



**DATOS MOTOR**

POTENCIA	4HP
REVOLUCIONES	1760
FRECUENCIA	60HZ
TORQUE MOTOR NOMINAL	16,6
CARCASA (PAM)	112(B5)
TIPO BRIDA	FF-215
EFICIENCIA MOTOR	IE 2

**DATOS REDUCTOR**

REFERENCIA	550028
TIPO	ORTOGONAL
MODELO	FCNDK
MATERIAL	HIERRO
CARCASA	130
RELACION DE TRANSMISION i:	60
VELOCIDAD SALIDA	29,33
TORQUE MAXIMO	910
TORQUE OPERACIÓN	717
FACTOR DE SERVICIO	1,3

**PLANOS REDUCTOR**

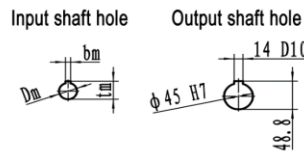
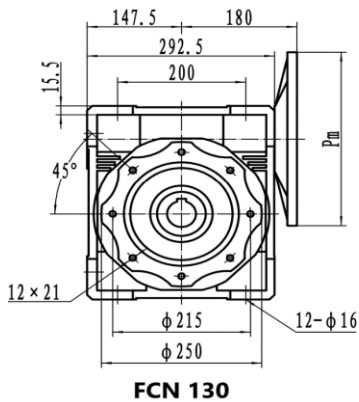

	Pm	Dm	bm	tm
90B5	200	24	8	27.3
90B14	140			
100/112B5	250	28	8	31.3
100/112B14	160			
132B5	300	38	10	41.3
132B14	200			

